



# Installation & Owner's Manual

English

This Manual Covers the

Following Models

HCV-APT-HDEX

HCV-APTHC-HDEX

**Manufactured by:**  
ClairiTech Innovations Inc.  
1095 Ohio Rd.  
Boudreau-Ouest, NB  
Canada E4P 6N4

---

## Table of Contents

<b>Table of Contents .....</b>	<b>1</b>
<b>Service and Warranty .....</b>	<b>3</b>
FOR CUSTOMER ASSISTANCE.....	3
CONSUMER LIMITED WARRANTY .....	4
PRE-INSTALLATION .....	5
INCLUDED COMPONENTS .....	5
TOOLS REQUIRED FOR INSTALLATION.....	5
KEY INSTALLATION FACTS.....	5
IMPORTANT – WHAT NOT TO DO.....	5
COMBUSTION APPLIANCE PRESENT IN DWELLING .....	6
IDEAL LOCATION OF THE UNIT .....	6
DUCTING .....	7
<b>Installation.....</b>	<b>7</b>
IDEAL INSTALLATION LOCATION.....	7
SELECTING THE DUCT LOCATION .....	7
PREPARING THE HUMIDEX FOR INSTALLATION .....	8
PUTTING THE UNIT TOGETHER.....	9
ATTACHING THE FLEX, PIPE AND OUTSIDE VENT .....	10
<b>Unit Operations .....</b>	<b>11</b>
THE FIRST TIME THE UNIT RUNS.....	11
VACANT HOMES.....	11
MAINTAINING YOUR HUMIDEX.....	11
<b>What is the dew point? .....</b>	<b>12</b>
<b>LCD Display and Control Layout .....</b>	<b>13</b>
THE LCD DISPLAY .....	14
NAVIGATING THE LCD MENU .....	14
CHANGING MAXIMUM FAN SPEEDS.....	15
CHANGING LOW SPEEDS .....	15
CHANGING DESIRED HUMIDITY LEVEL .....	16

## Humidex

---

SETTING OVERRIDE TIMER FOR MAXIMUM VENTILATION.....	16
UNIT MODES (NORMAL/AC/VACANT) .....	17
<i>AC Mode</i> .....	17
<i>Vacant Mode</i> .....	17
<i>Normal Mode (Default Mode)</i> .....	17
<b>Tamper Proof Lock Feature .....</b>	<b>18</b>
<b>Humidity Trend and Conditions.....</b>	<b>19</b>
HUMIDITY CONDITIONS .....	19
HUMIDITY TRENDS.....	19
<i>Stable Humidity Trend</i> .....	19
<i>Negative Humidity Trend</i> .....	19
<i>Positive Humidity Trend</i> .....	20
<i>High Humidity Conditions</i> .....	20
NOTES ON LCD DISPLAY FEATURES .....	20
NOTES ON MAINTENANCE.....	20
<b>Most Common Issues.....</b>	<b>21</b>
MOLD, MILDEW AND MUSTY SMELL.....	21
<b>Specifications.....</b>	<b>22</b>
TECHNICAL DATA.....	22
DIMENSIONS .....	22
ELECTRICAL BOX WIRING FOR APTHC MODELS.....	22
SCHEMATIC OF WIRING.....	23

## Service and Warranty

### For Customer Assistance

To aid in answering questions if you call for service or warranty purposes, please record below the model and serial number located on the side of the unit.

Product Name:
Model #:
Date of Manufacturing:
Date of Purchase:
Serial #:
Dealer Name (If Any):

**Please Note** the above information before contacting us.

**For the Following Inquiries:**

- Service
- Parts
- Accessories
- Additional Customer Information

**Please contact us by:**

Phone: 1-888-533-1348

Email: [support@clairitech.com](mailto:support@clairitech.com)

Website: [www.humidex.com](http://www.humidex.com)

### **IMPORTANT**

To properly validate your warranty, you must fill out and return the warranty card as soon as possible. If your unit is not registered, a proof of purchase will be necessary should it require any services. You can also register your warranty online <http://www.clairitech.com/register> .

### Consumer Limited Warranty

ClairiTech Innovations Inc. warrants to the first consumer that this product, when shipped in its original container, will be free from defective workmanship and materials, and agrees that it will, at its discretion, either repair the defect or replace the defective Product or part thereof with a new or remanufactured equivalent at no charge to the purchaser for the period(s) set forth below. The defective part must be returned to the manufacturer ClairiTech Innovations Inc. All transportation charges are the sole responsibility of the purchaser.

This warranty does not apply to any appearance items of the product nor to the additional excluded item(s) set forth below of which have been damaged, defaced, subjected to improper voltage, abnormal service or handling, or which has been altered or modified in design or construction.

In order to enforce the rights under this limited warranty, the purchaser must fill out and return the warranty card as soon as possible. If your unit is not registered, a proof of purchase will be necessary should it require any services.

Neither the sales personnel of the seller nor any other person is authorized to make any warranties other than those described herein, or to extend the duration of any warranties beyond the time period described herein on behalf of ClairiTech Innovations Inc.

The warranties described herein shall be the sole and exclusive warranties granted by ClairiTech and shall be the sole and exclusive remedy available to the purchaser. Correction of defects, in the manner and for the period of time described herein, shall constitute complete fulfillment of all liabilities and responsibilities of ClairiTech to the purchaser with respect to the Product, and shall constitute full satisfaction of all claims, whether based on contract, negligence, and strict liability or otherwise. In no event shall ClairiTech be liable, or in any way responsible, for any damages or defects in the Product which were caused by repairs or attempted repairs performed by anyone other than an authorized servicer, unless approved by ClairiTech in writing. Nor shall ClairiTech be liable or in any way responsible for any incidental or consequential economic or property damage.

Warranty Period for this product:	Ten (10) Years limited warranty Four (4) Years on electronic control
Additional Items Excluded from Warranty Coverage (If Any):	Appearance items of the product, Exterior vent and any printed material.
Where to obtain service:	From the Manufacturer. <b>Refer to Page 3 for Contact Information</b>

**This warranty is non-transferable and applies to residential use only.**

To obtain supply, accessory or product information, contact us.  
**Refer to Page 3 for Contact Information.**

## Pre-Installation

### Included Components

Before installing your Humidex, make sure that you have the right model and accessories. The following items should be included in the accessory box. If parts are missing, contact our customer service at US 1-888-533-1348, Can. 1-800-416-9111.

1x Owner's Manual	2x Cable Ties	6x #8 x 1/2" Screws
1x Warranty Card	1x Vinyl Flex 6" x 24"	1x Aluminum tape
1x Checklist	4x Plastic Anchors	4x Truss screws #8 x1 1/4
1x Exhaust Vent 6"	4x #8 x 2" Screws	

Additional grilles for replenishment air and interior rooms not included.

### Tools Required for Installation

- Electric reciprocal or hole saw 6 1/4"
- Drill with a 1/4" concrete bit
- Phillips or Robinson Screw Driver
- Measuring Tape
- Hammer
- Pencil

For concrete, cinderblock or brick installation, use a hammer drill with chiseling ability 1/2" x 16" long and a chisel bit 1" thick.

### Key Installation Facts

- 1) Unit must be installed at floor level – approximately 3" off the floor.
- 2) Unit should be installed as far away as possible from the source of replenishment air.
- 3) Outside duct must be no less than 6" and dedicated for the Humidex unit only.
- 4) Unit should not be installed within 4 feet of combustion appliance.

### IMPORTANT – What Not to Do

- 1) DO NOT install the unit more than approx. 3 inches off the floor.
- 2) DO NOT crush the vinyl Pipe.
- 3) DO NOT install the unit next to a replenishment air supply.
- 4) DO NOT install unit should within 4 feet of combustion appliance.

## Humidex

---

### **Warning!!!**

### Combustion Appliance Present in Dwelling Read this Section Carefully

With the presence of appliances evacuating air outside the building envelope (such as range hood, bathroom fan, dryer, Humidex, etc.) a negative pressure could be created inside the building. As the pressure inside the building gets lower than the barometric pressure outside, the smoke and gases from any combustion appliance (oil furnace, gas/wood stove, fireplace, etc.) **may be drawn into the building rather than go out the chimney.**

This problem if present, is usually curable by introducing make-up air inside the building. A fresh air kit (Air Supply Ventilator) is available from your Humidex dealer, to help relieve the effects of negative air pressure in the building.

### **Ideal location of the Unit**

- Air drawn in by Humidex pulls moisture off the surface floors and walls. To maximize the effectiveness, install the Humidex as far away as possible from the source of replenishment air. This will allow for the unit to draw in the maximum moisture across the greatest surface distance before the upstairs replenishment air is pulled into the unit.
- Keep away from sources of excess heat (i.e. furnace room).
- Unit must be installed all the way down to floor level, in order to draw in the moisture. **It should be approx. 3" and must not be higher than a max of 6 inches off floor level.**
- Keep at least 4 feet away from furnace or combustion appliance, to avoid interference.
- The area within a radius of 4 feet around the unit should be clear to allow the air to be pulled into the vents.

### **Ducting**

The duct should be vented above ground level to the outside or below ground into a window well that is open and not sealed off to the outdoors. The outside louver should be high enough to avoid infiltration of snow, flooding and rodents, etc. All necessary parts and outside louvers are included.

Make sure that no pipes, studs or wires are in the way. The duct has to be dedicated and not combined with any other existing ductwork in operation. Seal well around the outside opening.

## **Installation**

### **Ideal installation location**

To determine the best location, examine the dwelling for an outside wall where you could install the HCVS-APT or HCV-APTHC. This location should be as far as possible from sources of replenishment air such as windows, hallways and doors. Try to find a location where no electrical wires or pipes are present inside the wall. The unit has to be installed on an outside wall.

### **Selecting the Duct Location**

Now that you've decided where to install the unit, you must select a location for a 6¼" duct hole in the outside wall. This hole is needed to pass a duct through the outside wall. Make sure that the hole doesn't line up with a stud, electrical wires, or pipe.



## Preparing the Humidex for Installation

Measure the required Unit height. Remember that the units cannot be higher than 3" to 6" off the ground.

From the inside, drill a pilot hole of approximately 1/4" at the center of the proposed 6 1/4" hole.





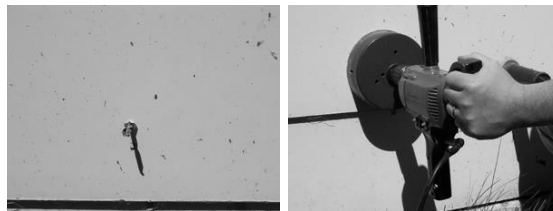

Outside the building, find the pilot hole. Using a hole-saw, with the pilot hole as a guide, drill a 6 1/4" hole.



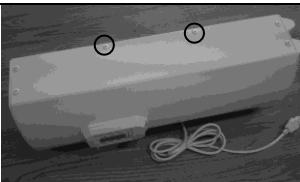

**Brick or Concrete Wall:** There are two ways of going through brick or concrete. The first method consists of using a hammer drill. Make holes (approximately 5/8") with the hammer drill 1" apart through the brick in a circular shape outlining the 6 1/4" hole. Finish cutting the outer edge of the hole using a chisel. If a hammer drill is not available, a chisel can be used. As brick is brittle chiseling from the center of the pilot hole will chip the brick easily. Continue chiseling until you reach the outer edge of the 6 1/4" hole.

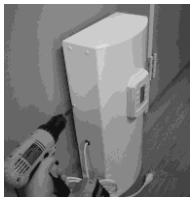
Putting the unit together

<p>Remove the 4 White Screws on the Side of the Unit. (These are along the back edge of the unit and are holding the Back Piece)</p>	
<p>Separate the Front Aluminum Piece from the back Galvanized piece.</p>	
<p>Place the Unit at its chosen location. Now scribe the four holes on the wall where the rubber grommets are installed. Remove the machine and drill four 1/4" holes where previously scribed. Apply anchors in the holes using a hammer.</p>	
<p>With the help of a tie wrap attach the flex pipe to the collar on the back of the unit before attaching the unit to the wall. Insert the other end of the flex pipe inside the hole in the wall. (a few Small 9/16" Screw can be used to affix the flex to the mount)</p>	
<p>Now fasten the unit to the wall using the 4 x 2" screws provided.</p> <p><b>NOTE:</b> For instructions on permanently connected model (APTHC), please see 'Electrical Box Wiring for APTHC Models', Page 22 for Wiring Instructions. <b>Please note that this model requires a qualified person for installation.</b></p>	
<p>Replace the front of the unit using the 4 Screw Caps with the 4 original screws.</p>	

## Humidex

### Attaching the Flex, Pipe and Outside Vent

<p>From the outside, pull the flex pipe through the 6 1/4" hole. Attach the flex to the 6" pipe with 24" tie wrap.</p>	
<p>Make sure the vent is not twisted by inserting the screws too tight and that the flaps are working properly.</p>	
<p><b>NOTE:</b> If high winds are often present in the location of the vent, they may cause a wind noise inside the house. If this is the case, an <b>anti-gust hood</b> (AGH-990) is available from your Humidex dealer.</p>	
<p>Plug the unit into any 115V outlet. <b>Note:</b> A grounded extension cord with a maximum length of 10 feet may be used if necessary.</p>	

### Unit Operations

#### **The first time the unit runs...**

Anytime the Humidex HCV unit is powered on (plugged into a power outlet), it will run at the last recorded speed setting (in memory) for 2 hours to allow air to circulate in house. The factory default setting when the unit is brand new is “High Speed”. After the initial two-hour period, the unit will begin to take readings of the environmental conditions of the air coming into the house (also called replenishment air). These readings help the unit regulate its operating speed to ensure that, over time, you will get the most energy efficient ventilation for the entire home and maximum reduction of relative humidity.

If this is the first time the unit is plugged in and allowed to run, it is important to allow it to run uninterrupted for those first two hours. After this time, you can change the Min/Max operating speed as well as the dehumidistat setting.

After power outages or whenever the unit is powered down (unplugged) and powered up again (plugged into the wall again), the unit reads the last recorded speed setting and dehumidistat setting and will operate with those parameters for a period of two hours before beginning to take readings of the environmental conditions of the incoming air. However, in this case, the user can access the menu and change settings and does not have to wait for this two-hour period to be over.

**Note:** For the unit to function properly and to allow the unit to provide the best energy efficient ventilation and humidity control, all windows, doors with access to the outdoor and vents to the outdoor should be closed to prevent an excessive amount of outdoor air from entering directly into the house.

#### **Vacant Homes**

Performance results are maximized when the building is occupied. If home is vacant for a prolonged period of time, then the unit should be set to operate at low speed. A fresh air intake supply is recommended via a small opening in a window upstairs or a supply vent such as the ASV-90.

#### **Maintaining your Humidex**

Do not store anything within a radius of 4 feet around the base of the Humidex.

The only maintenance needed for your Humidex is a periodic vacuuming of the dust accumulation at the intake grilles or louvers located at the bottom of the unit.

## What is the dew point?

The dew point is one of the three environmental variables that are important when discussing the conditions in your home. Understanding the dew point will help you understand how the Humidex HCV unit operates and how it will help to reduce the relative humidity (RH%) level infiltrating your home and eliminate excess humidity, while providing energy efficient ventilation for your home. The dew point is defined as the temperature at which the water vapor contained in a given volume of air will condense into water. This is best illustrated by an example:

Assume the following measurements are taken by the unit:

Temperature = 68<sup>0</sup>F

Relative Humidity = 60%

Using the temperature and RH% values measured, we would calculate that the dew point in your home is 54<sup>0</sup>F. As the temperature of surfaces in your dwelling (these tend to reflect the floor temperature, which is generally cooler than the ceiling air temperature) approaches the value of the dew point, you risk having condensation on those colder surfaces (as well as un-insulated water pipes). This condensation can lead to problem situations that might produce unhealthy living conditions in your home (odors, molds, etc.)

### COLD SURFACE FACTS – IMPORTANT

It is recommended that any exposed cold water pipes and A/C ducts should be insulated to reduce condensation on these cold surfaces

## LCD Display and Control Layout

The following sections of this operating manual refer to the user interface presented below:

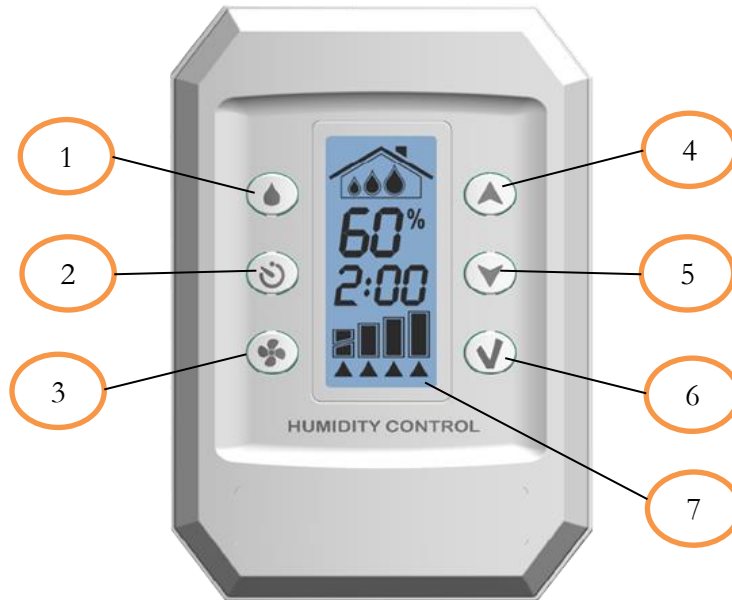

The user interface consists of:

- 1- Humidity Button
- 2- Override Timer Button
- 3- Fan Speed Button
- 4- Up Arrow Button
- 5- Down Arrow Button
- 6- Ok Button
- 7- LCD Display

### The LCD Display

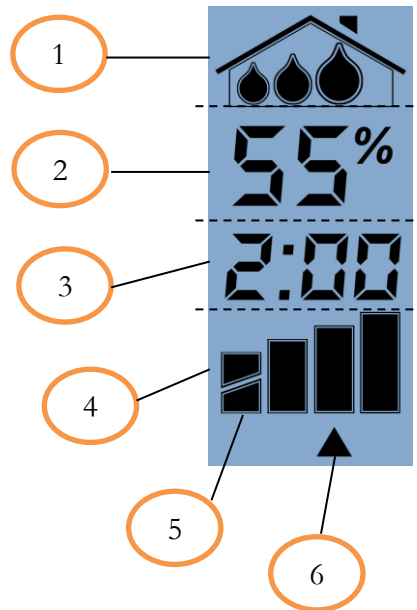

The LCD Display consists of:

- 1- Humidity Conditions and Trending Icons
- 2- User Set Humidity Level
- 3- Override Timer
- 4- User Set & Operating Fan Speed
- 5- Low1/Low2 Fan Speed Indicator
- 6- Desired Max Fan Speed Indicator

### Navigating the LCD Menu

The Humidex unit has an LCD display that allows the unit to display information about its operation. The LCD display also has a six button user interface that allows the user to navigate the LCD menu and change settings such as the maximum operating speed of the unit, the dehumidistat setting, as well as access the unit's built in override mode. The following sections explain how to navigate the LCD menu and change the settings, as well as how to access the override mode.

### Changing Maximum Fan Speeds

To change the maximum fan speeds, simply press the Fan Speed Button (The Desired Max Fan Speed Indicator will blink) and use the Up/Down Arrow Buttons to cycle through all of the different fan speeds and to select this speed simply press the Ok Button when you have the desired fan speed. If wrong speed is entered, repeat this procedure.

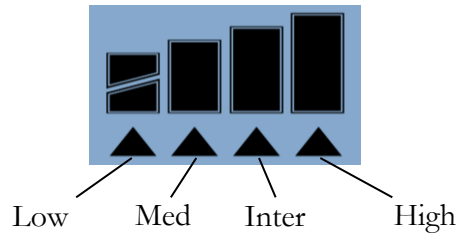

Maximum Operating Speed	Airflow (CFM)
	HCV-APT HCV-APTHC
High	125
Intermediate	95
Medium	75
Low1/Low2	35/60

*\*These speeds may vary depending on installation*

The solid bars will denote the actual speed at which the fan is operating, the arrow below denotes the maximum chosen setting.

\*\* Please note the unit will not exceed the maximum user set fan speed, unless the override mode is running. The control will choose the proper fan speed depending on humidity, temperature and dew point conditions.

### Changing Low Speeds

To change the minimum ventilation speed simply press and hold the Fan Speed Button for 10 seconds (the Low Speed bars will start blinking); Use the Up/Down Arrow Buttons to cycle through all of the different fan speeds and to select this speed simply press the Ok Button when you have the desired fan speed. If wrong speed is entered, repeat this procedure.

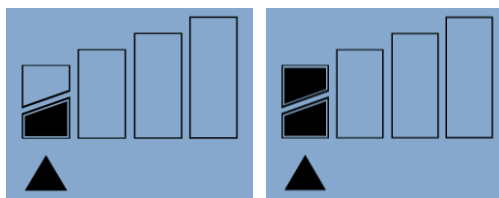



## Humidex

---

### Changing Desired Humidity Level

To change the desired humidity, simply press the Humidity Button (the humidity setting will blink) and use the Up/Down Arrow Buttons to cycle to your desired humidity level. Press the Ok Button to enter your desired humidity level. If wrong level is entered, repeat this procedure.



\*\* Recommended humidity level for summer season is 55% and 45% for the winter season. Please note this does not show current humidity level, but rather the desired humidity level.

### Setting Override Timer for maximum ventilation

The override function permits you to provide maximum ventilation for a predetermined amount of time, regardless of the fan speed chosen by the computerized/sensor control, to alleviate certain conditions IE fumes from new paint, flooring, furniture or excess moisture from hot showers, cooking, etc. To override the unit, you simply press the Override Button (the time clock icon will blink until the desired override time is selected) and use the Up/Down Arrow Buttons to cycle through the different override timer options. Once the desired override time is chosen, press the Ok Button to begin override. If wrong time is entered, repeat this procedure.



\*\* The override timer will reduce as time goes by indicating the remaining time left. When the override time expires the unit will revert to settings, prior to activating the override function. The unit will continue to take readings during the override to ensure that the unit will automatically make any required necessary ventilation adjustments at the expiry of the override.

### Unit Modes (Normal/AC/Vacant)

The HCV-APT Unit has 3 Special built in Modes that allows it to run more efficiently when a home is either Vacant for periods of time or when a home has an Air Conditioner.

#### AC Mode

The AC Mode is specially programmed for homes with Air Conditioners that operate consistently for more than 6 Hours a day. This mode allows for the unit to recognize when an AC unit is running and will create specific conditions as so to not put a strain on the AC.

#### Vacant Mode

This mode is specially programmed for vacant homes if you're away for more than 5-7 days, switching to Vacant Mode will be beneficial for your home.

#### Normal Mode (Default Mode)



This mode is set by default; it should be used when AC Mode or Vacant Mode does not apply.

How to switch between modes:

- 1) Press and Hold the Humidity Button down for 10-12 Seconds. The words NO, VAC or AC will start flashing in the Timer Area.
- 2) Use the Up/Down Arrows to cycle through the modes.
  - a. NO: Normal Mode
  - b. VAC: Vacant Mode
  - c. AC: AC Mode
- 3) Once the desired mode is shown on the screen, push the OK Button to activate the mode. The selected mode will stop blinking for 3 seconds and disappear.

After selecting a mode, The House Icon at the top of the LCD will start to react differently. This will allow you to determine which mode the Unit is actually set to.

The Following is an example of how the House Icon will display when a specific mode is selected.

Normal Mode	Vacant Mode	AC Mode
		
The House Icon will Remain Solid	The House Icon will Disappear	The House Icon will Continuously Blink

**Note:** Specific humidity settings have been programmed for each mode. It is normal that your desired humidity setting is changed automatically when you change the Unit Mode.

## Tamper Proof Lock Feature

The HCV-APT has a Special feature that can be activated to protect your unit from being tampered with or accessed by minors. This feature does not allow any changes (Desired Humidity, Fan Speed, Override) to be made without the permission of the owner. This is a feature that is often utilize when a unit is installed in a rented home, condo or apartment.

By default, The Tamper Proof Feature is disabled on all HCV-APT Units. Once the feature is activated, it will require a complete factory reset to disable it. Please contact our technical support for more information.

To activate the Lock Feature, Press and Hold the UP Arrow Button for ~10 Seconds.

When the Lock is activated, it will display the following on the LCD Screen.



The Lock can temporarily be disabled by holding the Up Arrow button for 10 seconds. Settings on the control can then be changed (Humidity%, Override, Fan Speed). However the lock will automatically re-enable within 10 seconds of no activity.

## Humidity Trend and Conditions

### Humidity Conditions

At the top of the LCD display the house with or without the 3 water drops are used to show the current humidity conditions. The image below demonstrates the different humidity conditions shown on the LCD display.

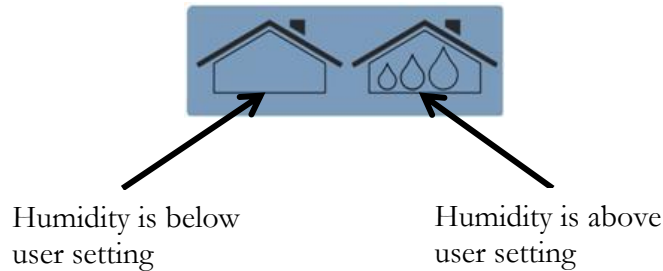

### Humidity Trends

The three drops inside the house at the top of the LCD display are also used to show the current humidity trend, when the humidity is above the desired setting.

#### Stable Humidity Trend

The three drops will stay illuminated constantly when a stable trend is detected, with either outline or solid drops used to indicate the condition, as above.



#### Negative Humidity Trend

The water drops will blink from left to right when an increasing humidity trend is detected.

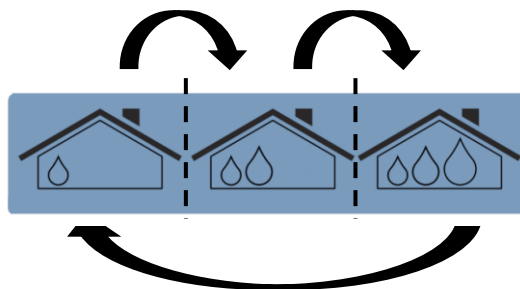

## Humidex

---

### Positive Humidity Trend

The water drops will blink from right to left when a decreasing humidity trend is detected, with either outline or solid drops used to indicate the condition, as above.

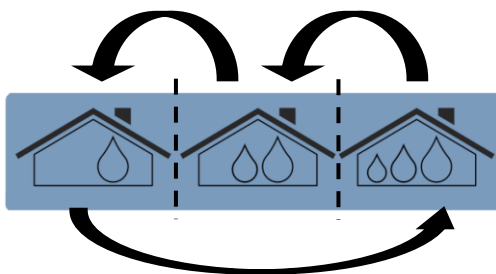

### High Humidity Conditions

If the water drops are solid, this means that the unit has detected high humidity conditions.



### **Notes on LCD display features**

- 1) The LCD display on this unit has a built in backlight to allow for better readability in darker locations. This backlight turns on when any button on the control panel is pressed and turns off after no button has been pressed on the unit for a period of 2 minutes.
- 2) When the LCD is left displaying a menu in which user input is required, but no input is given within 2 minutes, the unit will exit the menu and return to its normal operation, based on previous settings for which a confirmation was given.
- 3) The unit is fully automatic once set, requiring adjustments only if you wish to change the settings.

### **Notes on Maintenance**

The HCV Products do not require any internal maintenance. These systems do not have any filters to clean or buckets to empty. The manufacturer does however suggest to vacuum the bottom vents of the unit twice a year. This will prevent them from being blocked and diminishing the performance of the system.

## Most Common Issues

### Mold, Mildew and Musty Smell

If mold or mildew is present prior to installing a Humidex, please have the contaminated area cleaned. Not doing so could cause the Humidex to spread that mold to other locations.

To avoid Mold, Mildew or Musty Smells:

- Follow the Recommendations on Page Error! Bookmark not defined. (Concerning New Installations in the summer).

To ensure the proper functionality of the Humidex:

- Increase ventilation in remote areas with a portable fan.
- Any exposed pipes and ducts should be insulated.
- Rainwater from the roof should be directed away from the foundation.
- Landscaping should slope away from foundations.

Do not attempt to service the Humidex yourself. If you are not sure about certain functions, **please refer to Page 3.**

## Specifications

### Technical Data

Model	Amps (A)	Watts (W)	Airflow (CFM)	Capacity (Sq.Ft.)
HCV-APT-HDEX	0.30	34	125	2,000
HCV-APTHC-HDEX	0.30	34	125	2,000

All Units require a 115 VAC electrical outlet

### Dimensions

Model	Height (In.)	Width (In.)	Depth (In.)
HCV-APT-HDEX	23.5"	9.5"	5.5"
HCV-APTHC-HDEX	23.5"	9.5"	5.5"

\*A 24 Inch extension section is available if extra height is required

### Electrical Box Wiring for APTHC Models

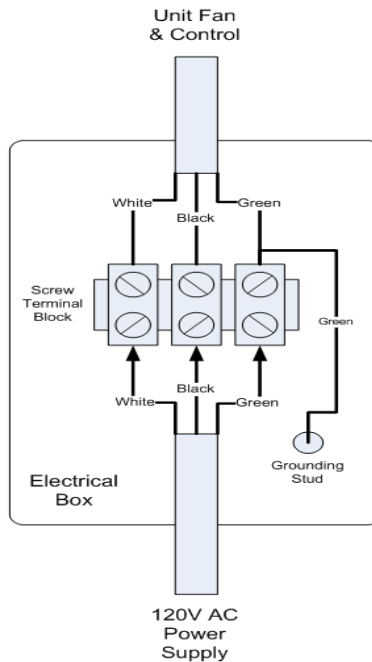

# Humidex

## Schematic of Wiring

Follow the wiring schematic below when the fan and/or controls need to be serviced or replaced.

